



UNIVERSITY OF CAMBRIDGE INTERNATIONAL EXAMINATIONS
International General Certificate of Secondary Education

CANDIDATE
NAME

CENTRE
NUMBER

--	--	--	--	--

CANDIDATE
NUMBER

--	--	--	--

MANDARIN CHINESE

0547/01

Paper 1 Listening

May/June 2012

Approx. 35 minutes

Candidates answer on the Question Paper.

No Additional Materials are required.

READ THESE INSTRUCTIONS FIRST

Write your Centre number, candidate number and name on all the work you hand in.
Write in dark blue or black pen.
Do not use staples, paper clips, highlighters, glue or correction fluid.
DO NOT WRITE IN ANY BARCODES.

Answer **all** questions in **Section 1**, **Section 2** and **Section 3**.

At the end of the examination, fasten all your work securely together.
The number of marks is given in brackets [] at the end of each question or part question.



For Examiner's Use	
Section 1	
Section 2	
Section 3	
Total	

This document consists of **10** printed pages and **2** blank pages.



第一部分

Section 1

练习一，问题一至五

Exercise 1 Questions 1-5

你将听到几个中文句子，每个句子两遍。在唯一正确的方格内打勾(✓) 回答问题。

You will hear some short phrases in Chinese. You will hear each phrase twice. Answer each question by ticking (✓) 1 box only.

你在中国。

You are in China.

1 在商店，你听到：

什么卖完了？

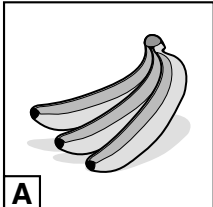
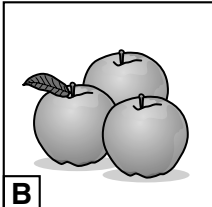
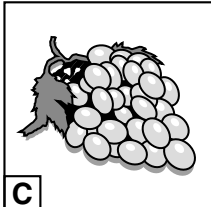
A			
B			
C			

[1]

2 在教室，你听到：

今天有什么课？

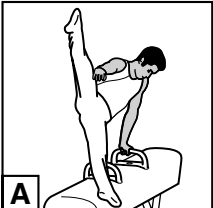
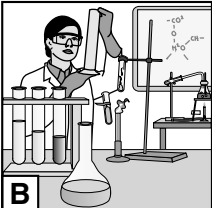
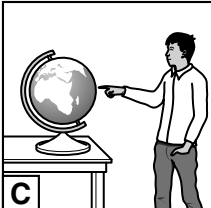
A			
B			
C			

[1]

3 在街上，你听到：

她去哪儿？

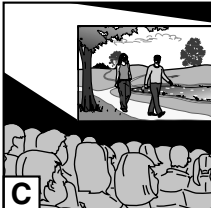
A			
B			
C			

[1]

4 在学校，你听到：

同学们送给她什么？

A	
B	
C	

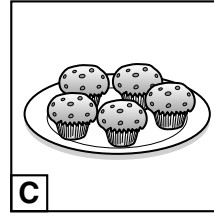
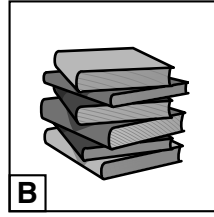
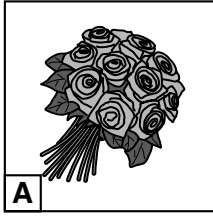

[1]

5 在街上，你听到：

飞机场在哪儿？

A	
B	
C	

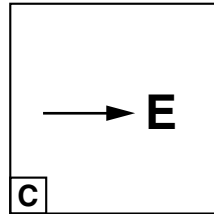
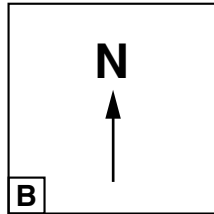
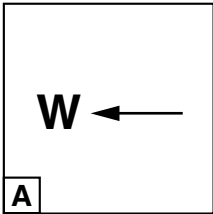

[1]

[Total: 5]

练习二，问题六至十

Exercise 2 Questions 6–10

小红在讲他的生日是怎么过的。请看图片。
Xiao Hong talks about how he spent his birthday. Look at the pictures.

请听下面的对话，在唯一正确的方格内打勾(✓)回答问题。
Listen, and answer each question by ticking (✓) 1 box only.

6 07:00 

A	<input type="checkbox"/>
B	<input type="checkbox"/>
C	<input type="checkbox"/>

A

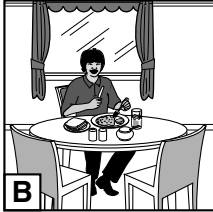

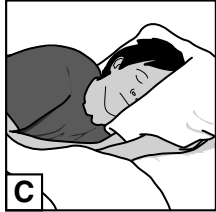
B



C

[1]

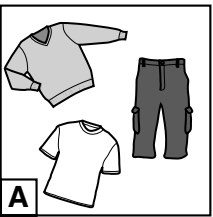
7 09:00 

A	<input type="checkbox"/>
B	<input type="checkbox"/>
C	<input type="checkbox"/>

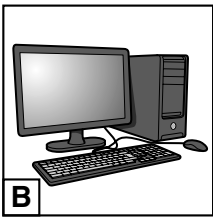
A

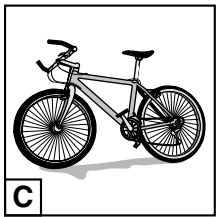

B



C

[1]

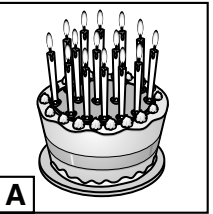
8 12:00 

A	<input type="checkbox"/>
B	<input type="checkbox"/>
C	<input type="checkbox"/>

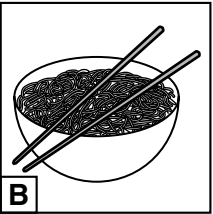
A

B

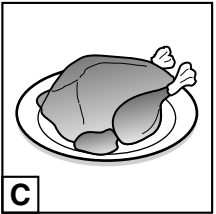

C

[1]

9 14:00

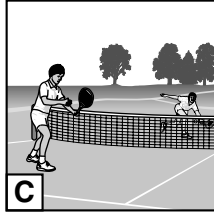
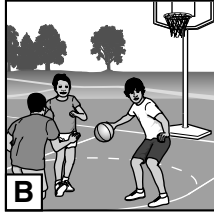
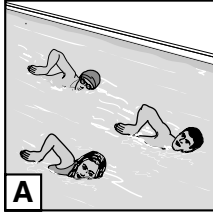

- A
- B
- C



[1]

10 19:00



- A
- B
- C

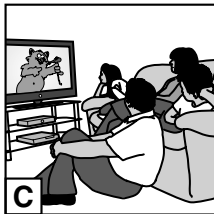
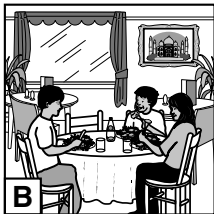

[1]

[Total: 5]

第二部分 Section 2

练习一，问题十一至十五 Exercise 1 Questions 11-15

你去一家大商场买东西，服务员给你介绍。请看图片。

You are shopping at a big department store. A shop assistant informs you. Look at the pictures.

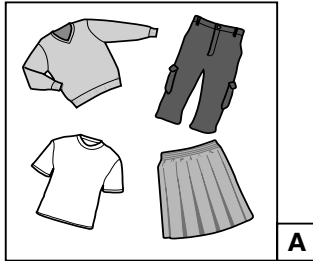

A



B

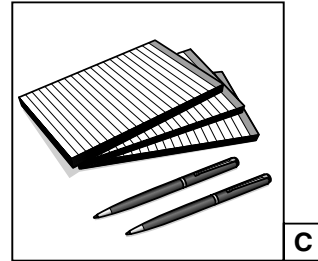

C

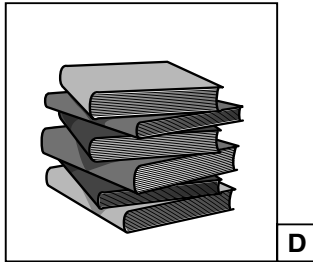

D

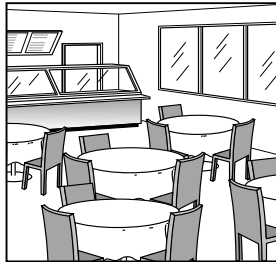

E

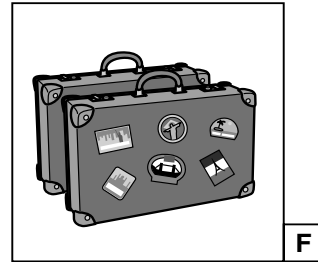

F

请听下面的录音，选择正确的图片回答问题，将字母填入方格内。
Listen, and for each floor choose the correct letter.

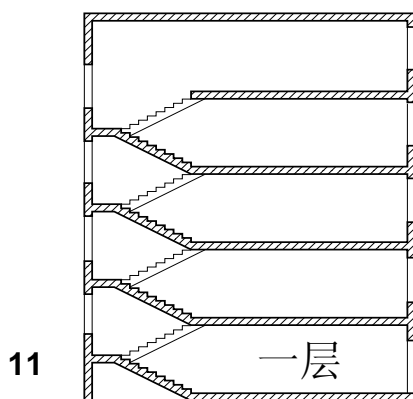

11

[1]

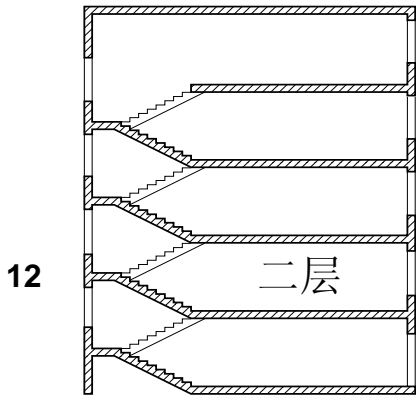

12

二层

[1]

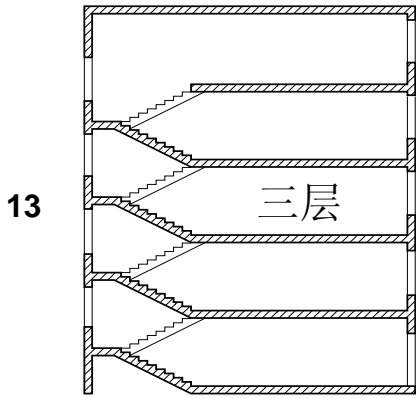

13

三层

[1]

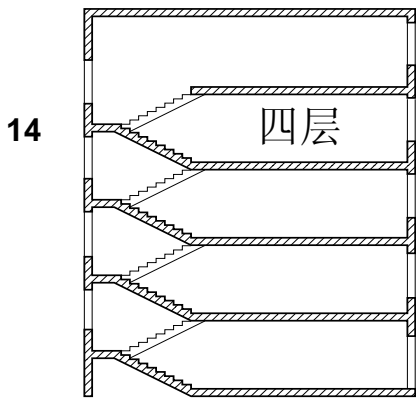

14

四层

[1]

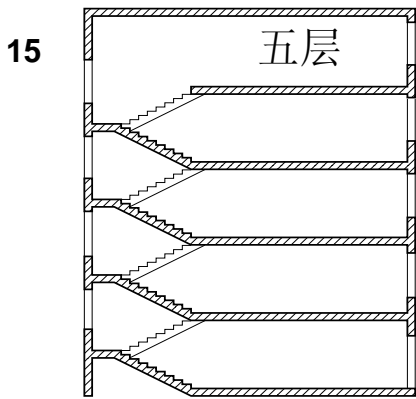

15

五层

[1]

[Total: 5]

练习二，第十六个问题

Exercise 2 Question 16

小林到了云南的一个度假村。他跟接待人员说话。请看图片。
Xiao Lin just arrived at a holiday village in Yunnan. He is talking with the receptionist. Look at the pictures.

请听下面的对话，在五个正确的方格内打勾(✓)标明度假村提供哪些设施。

Listen, and tick (✓) 5 boxes to show the facilities in the holiday village.

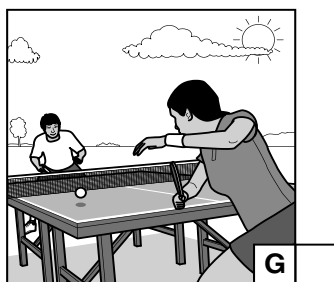
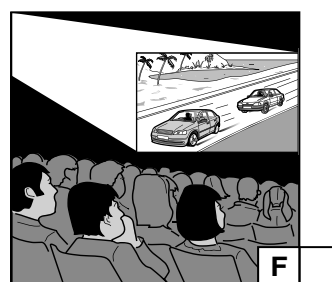
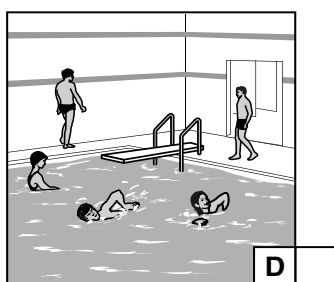
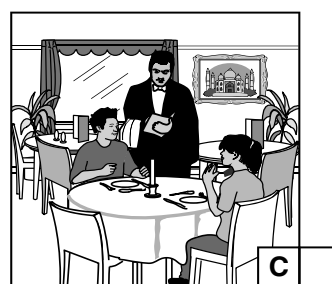
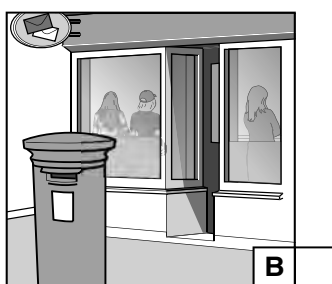
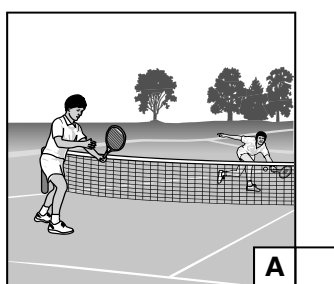

[Total: 5]

第三部分 Section 3

练习一，问题十七至二十一 Exercise 1 Questions 17–21

朋友们一起谈他们的暑假。请看图片。
Friends talk about their summer holidays. Look at the pictures.

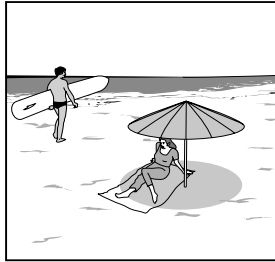

A



B



C

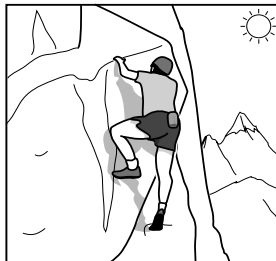

D

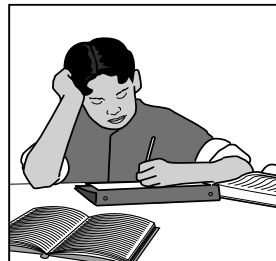

E



F

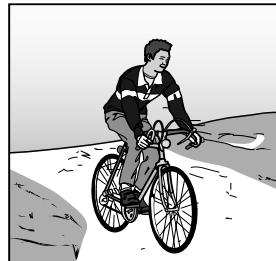

G

请听下面的录音，选择正确的图片回答问题，将字母填入方格内。
Listen, and for each young person choose the correct letter.

- | | | |
|-------------------|--------------------------|-----|
| 17 李明 (Li Ming) | <input type="checkbox"/> | [1] |
| 18 张伟 (Zhang Wei) | <input type="checkbox"/> | [1] |
| 19 王兰 (Wang Lan) | <input type="checkbox"/> | [1] |
| 20 黄文 (Huang Wen) | <input type="checkbox"/> | [1] |
| 21 林立 (Lin Li) | <input type="checkbox"/> | [1] |

[Total: 5]

练习二，问题二十二至二十五

Exercise 2 Questions 22–25

对一名住读学校学生的采访。请先阅读一下问题。

An interview with a boarding school student. Read the questions.

请听下面的采访，用中文或拼音回答问题。

Listen, and answer the questions in Chinese. You may write your answers in Chinese characters or pinyin.

22 记者为什么采访张月?

..... [1]

23 三年前张月为什么选择住读?

..... [1]

[PAUSE]

24 张月说住读有哪两个好处?

i) [1]

ii) [1]

25 为什么张月最喜欢晚上睡觉的时候?

..... [1]

[Total: 5]

